

ALL MODULES

WYLER SPEC

ALLE MODULE

GEOMETRY

GEOMETRIE



MODULE 1 - LINE

MODUL 1 - LINIE

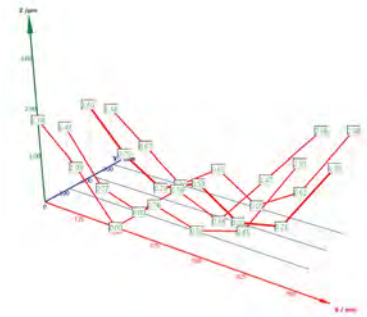
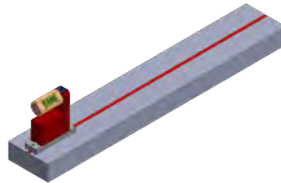

MODULE 2 - LINE WITH TWIST

MODUL 2 - LINIE MIT TWIST

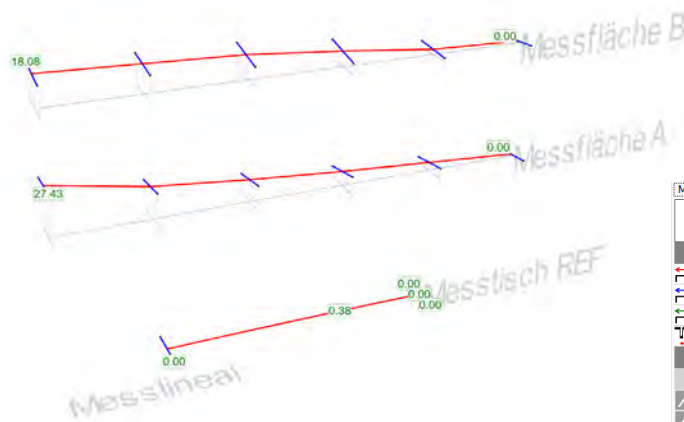
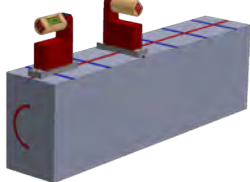
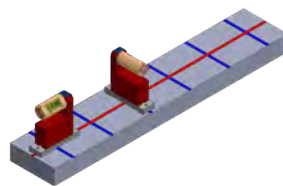
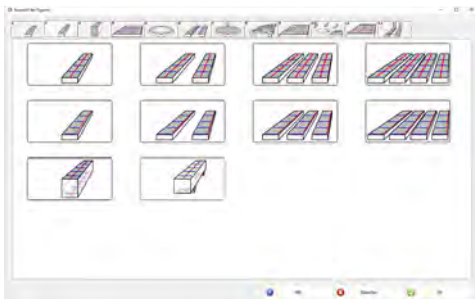

Messlineal	Messflache REF	Messflache A	Messflache B
Definition measurement object			
X			500 mm
Y			50 mm
Z			70 mm
			280 mm
Evaluation (Measurement device - Reference) - ISO 1101			
05.02.2020 11:33			
	Messflache A -> Messflache REF		27.43 μm
	Messflache B -> Messflache REF		18.08 μm

MODULE 3 - PERPENDICULARITY

MODUL 3 - RECHTWINKLIGKEIT

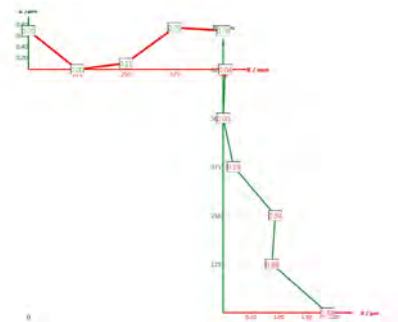
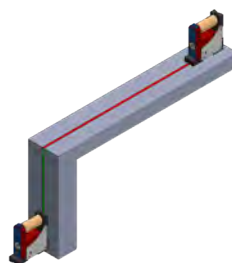
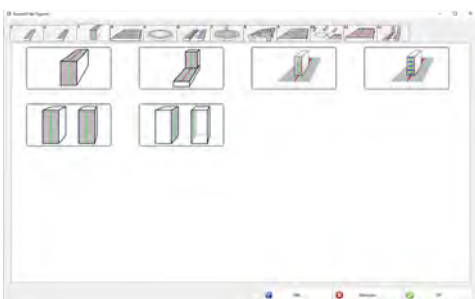

ALL MODULES

WYLERSPEC

ALLE MODULE

MODULE 4 - FLATNESS

MODUL 4 - EBENHEIT

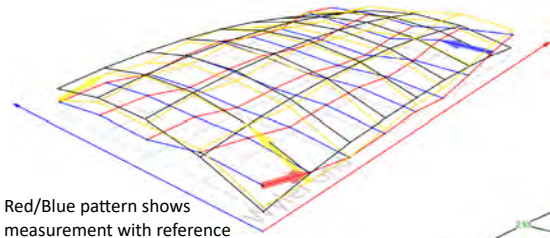
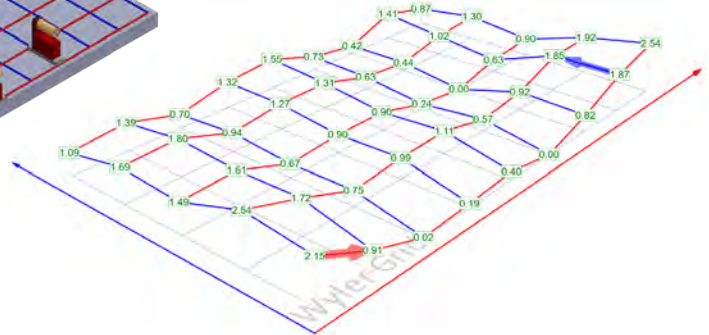
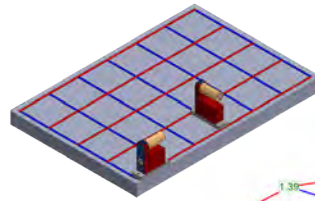

Red/Blue pattern shows measurement with reference

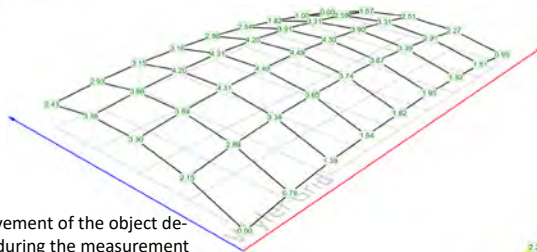

Black pattern shows movement of the object detected by the reference during the measurement

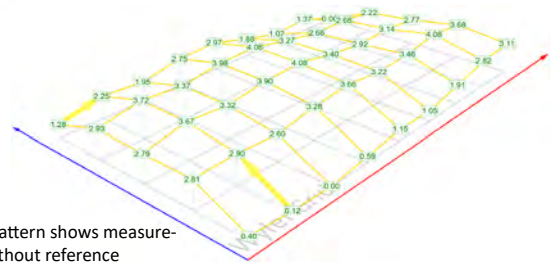

Yellow pattern shows measurement without reference

MODULE 5 - CIRCLE

MODUL 5 - KREISE

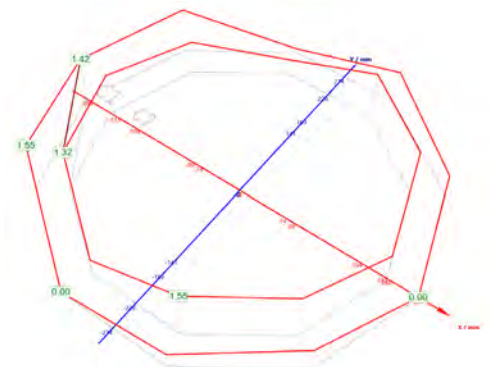
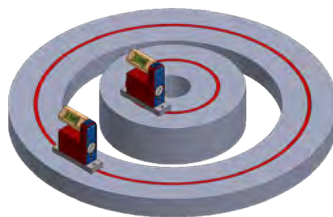
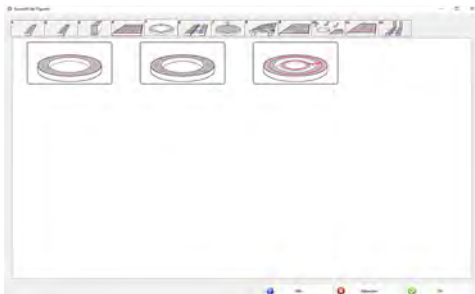

Red/Blue pattern shows measurement with reference

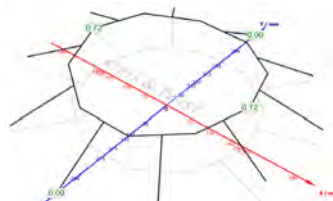
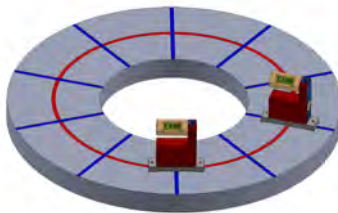

Black pattern shows movement of the object detected by the reference during the measurement



Yellow pattern shows measurement without reference

ALL MODULES

WYLERSPEC

ALLE MODULE

MODULE 6 - GUIDEWAYS

MODUL 6 - FÜHRUNGSBAHNEN

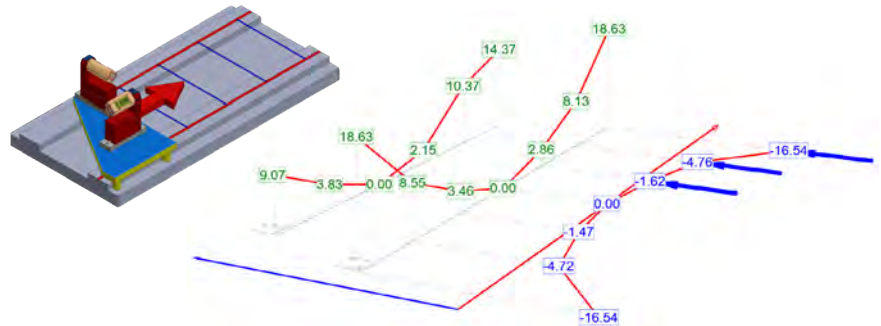

MODULE 7 - VERTICAL SPINDLE TO TABLE

MODUL 7 - VERTIKALE SPINDEL ZU TISCH

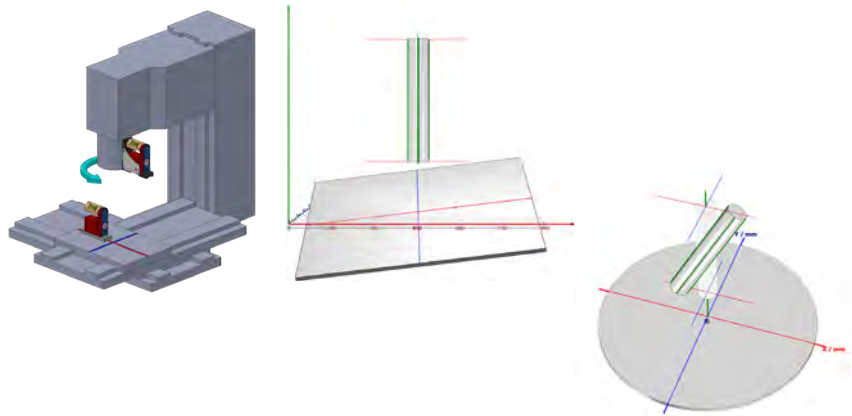

MODULE 8 - MOVING GEOMETRY (ROTATION)

MODUL 8 - BEWEGTE GEOMETRIE (ROTATION)

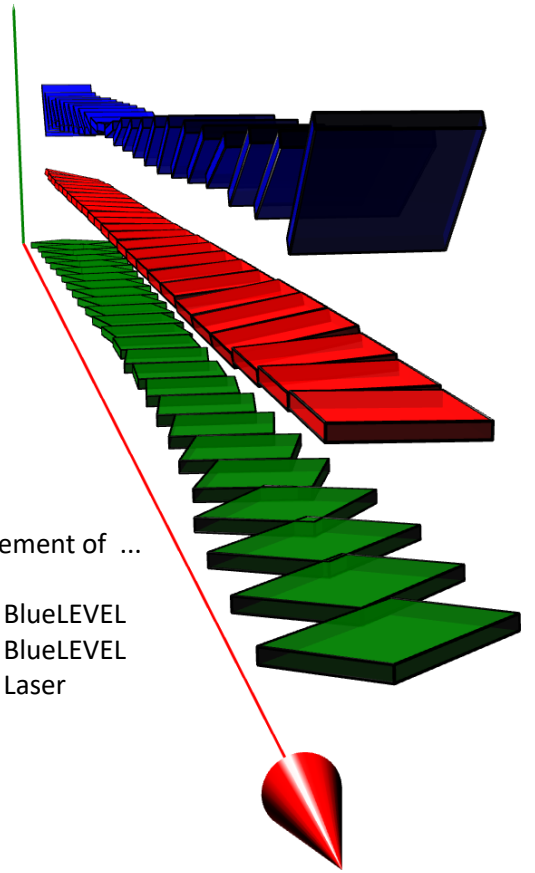
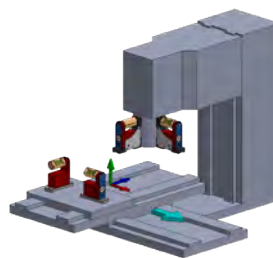

Display result as Lollipop

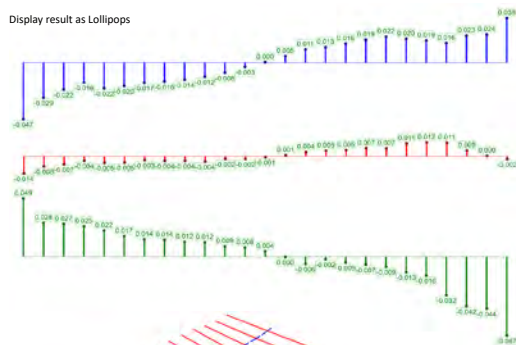

Display result as 3D

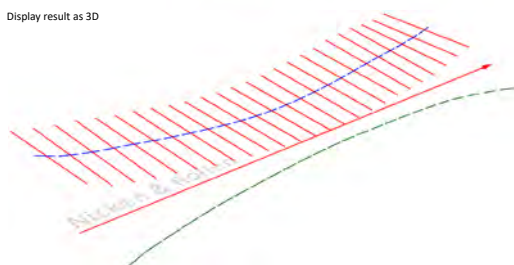

Measurement of ...

- PITCH** BlueLEVEL
- ROLL** BlueLEVEL
- YAW** Laser

ALL MODULES

WYLERSPEC

ALLE MODULE

MODULE 9 – GRID FLATNESS AND PARALLELISM

MODUL 9 – GRID EBENHEIT UND PARALLELITÄT

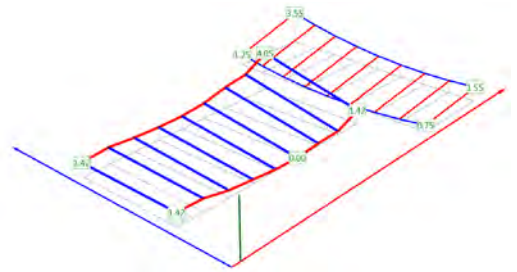
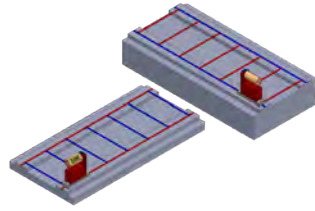
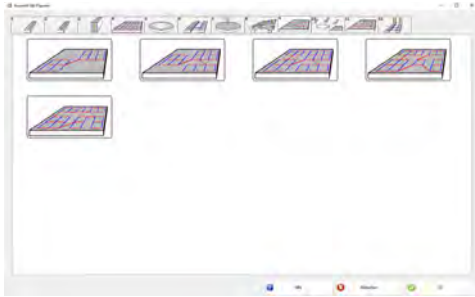

Parallelism of areas

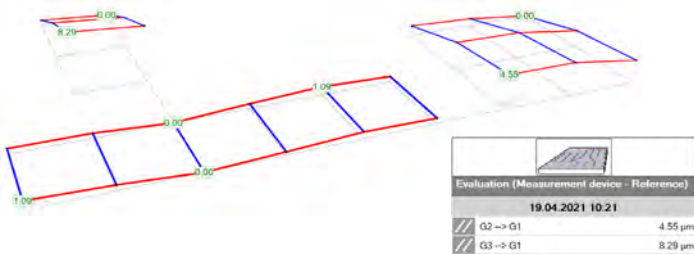

Coplanarity of areas



MODULE 10 – OWN MEASURING FIGURES  
Flatness and parallelism

MODUL 10 – EIGENE MESSFIGUREN  
Ebenheit und Parallelität

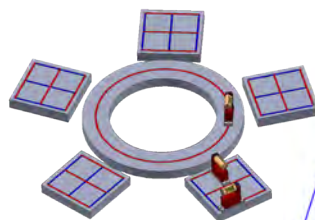
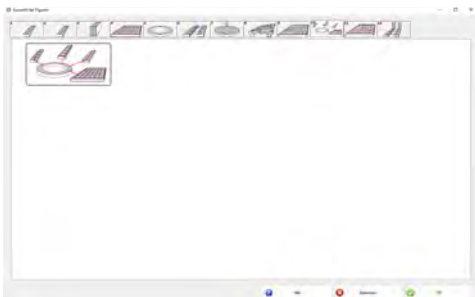

Parallelism of areas

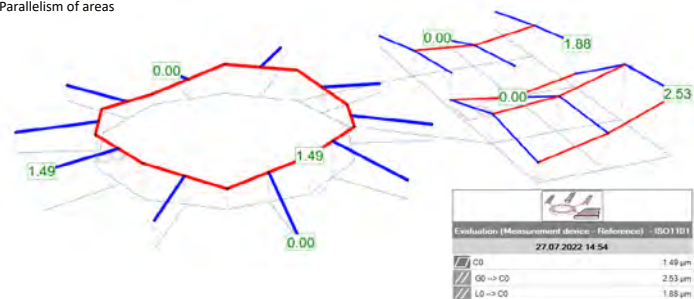

Coplanarity of areas



ALL MODULES

WYLERSPEC

ALLE MODULE

MODULE 11 – TREND

MODUL 11 – TREND

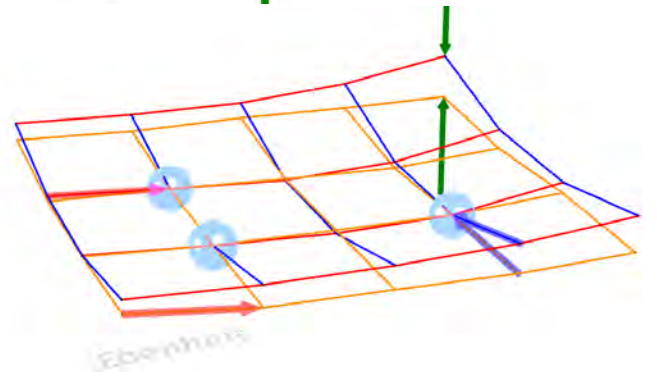
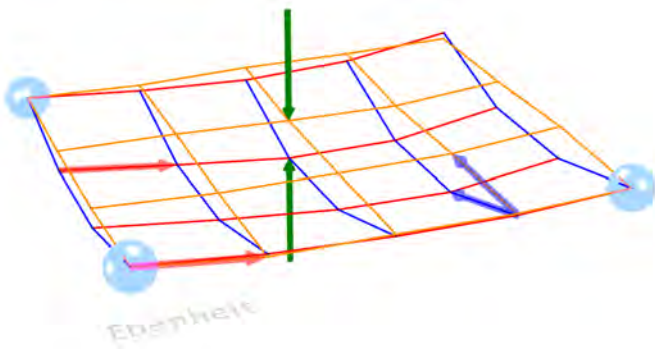
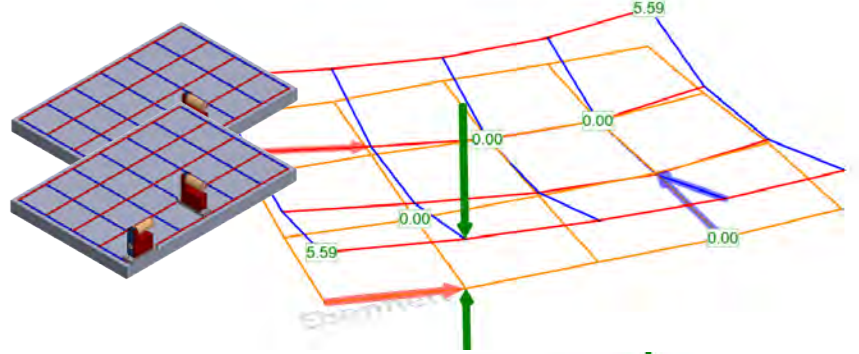

MODULE 12 – COMBINATION

MODUL 12 – KOMBINATION

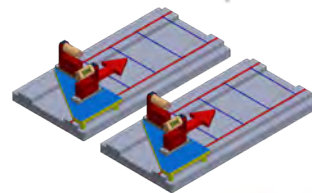
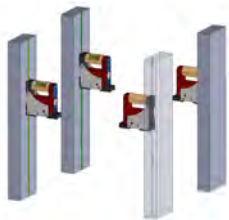
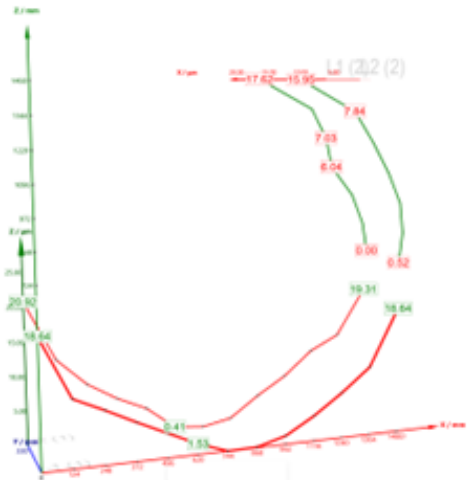
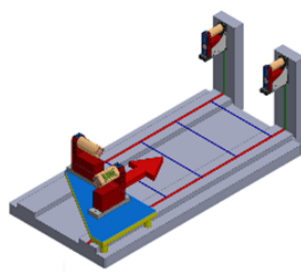

**WYLERELEMENTS  
WYLERPROFESSIONAL  
WYLERSPEC**

GEOMETRYGEOMETRIE

License Lizenz	P/N Produktnummer	Modules Module		
		1	4	
	1.	029-ELEMENTS-L1		
	2.	029-ELEMENTS-L2		

License Lizenz	P/N Produktnummer	Modules Module					
		1	2	3	4	8	
	1.	029-PROF-L1					
	2.	029-PROF-L2					
	Upgrade Wyler ELEMENTS	029-PROF-UP-F					

License Lizenz	P/N Produktnummer	Modules Module												
		1	2	3	4	5	6	7	8	9	10	11	12	
	1.	029-SPEC-L1												
	2.	029-SPEC-L2												
	Upgrade Wyler PROFESSIONAL	029-SPEC-UP-F												

System requirements	System-Anforderungen
Microsoft Windows WIN 10, 8 GB RAM, 4 Core, 1x USB 2.0 Optimized for resolution 1920x1080	

Scope of delivery	P/N Produktnummer	Lieferumfang
Software per download from our website <a href="http://www.wylerag.com">www.wylerag.com</a> Note: Software requires license management wylerCONNECT		Software downloadbar von unserer Webseite <a href="http://www.wylerag.com">www.wylerag.com</a> Hinweis: Software benötigt Lizenzmanagement wylerCONNECT
	See above	Siehe oben

Scope of delivery	P/N Produktnummer	Lieferumfang
Set with ...		Set mit ...
<ul style="list-style-type: none"> <li>wylerCONNECT incl. license for separately ordered software</li> <li>wylerTRIGGER</li> <li>USB-C cable 1.4 m, Universal cable 0.5 m</li> <li>Quick reference</li> </ul>	029-0001-001	<ul style="list-style-type: none"> <li>wylerCONNECT inkl. Lizenz für separat bestellte Software</li> <li>wylerTRIGGER</li> <li>USB-C Kabel 1.4 m, Universalkabel 0.5 m</li> <li>Kurzanleitung</li> </ul>
Set in storage case with ...		im Aufbewahrungskoffer mit ...
<ul style="list-style-type: none"> <li>wylerCONNECT incl. license for separately ordered software</li> <li>wylerTRIGGER</li> <li>USB-C cable 1.4 m, Universal cable 0.5 m</li> <li>Quick reference</li> </ul>	029-0001-002	<ul style="list-style-type: none"> <li>wylerCONNECT inkl. Lizenz für separat bestellte Software</li> <li>wylerTRIGGER</li> <li>USB-C Kabel 1.4 m, Universalkabel 0.5 m</li> <li>Kurzanleitung</li> </ul>