

SMART FACTORY



# EVOSET

...for best measuring results

# Content

---

<b>EVOSET</b> .....	03
<b>OPTIMA SERIES</b>	
OPTIMA CNC .....	06
OPTIMA .....	07
OPTIMA Basic .....	08
OPTIMA Special Solutions .....	08
OPTIMA Wood .....	09
TOOL BOY .....	11
<b>OPTIONS &amp; ACCESSORIES</b> .....	11
<b>CNC ADAPTERS   REDUCTIONS   ADAPTERS</b> .....	12
<b>SOFTWARE® EYERAY</b> .....	13
CNC Buzzard Hawk Wood	
<b>SMART FACTORY SOLUTION</b> .....	16
Digitalization Data transfer	
<b>SERVICE &amp; SUPPORT</b> .....	19

---

**EVOSET** is one of the world's leading companies in the field of tool **presetting and measuring**.

We combine productivity with absolute ease of use, including customised solutions for individual projects, all the way to **complete solutions for tool management and integration of all manufacturing processes**.

The products focus on optimum implementation of individual customer requirements. EVOSET strives for intelligent and complementary solutions in the field of tool presetting, measurement and inspection. Many years of experience and in-house development of devices and software as well as our engineering team guarantee know-how and success for your production.

This allows companies with a large machinery portfolio to increase precision and productivity per unit by up to 20 per cent.

We offer our customers professional worldwide service to supplement our strong product development and manufacturing activities. Our highly qualified engineers support you from planning to commissioning.

As a partner to the manufacturing industry, EVOSET continuously develops new Swiss quality products to further optimize processes in the industry.

Your satisfaction and your success are our highest priorities.

**Your EVOSET team**

# THE OPTIMUM SOLUTION V PREMIUM MODULAR SYST M

---

**EVOSET** Offers the most efficient solution for setting, measuring, testing and managing your tools.

PRESETTING

---

MEASURING

---

TOOL INSPECTION

---

EYERAY<sup>®</sup> SOFTWARE

---

SMART FACTORY

---

DIGITALIZATION

---

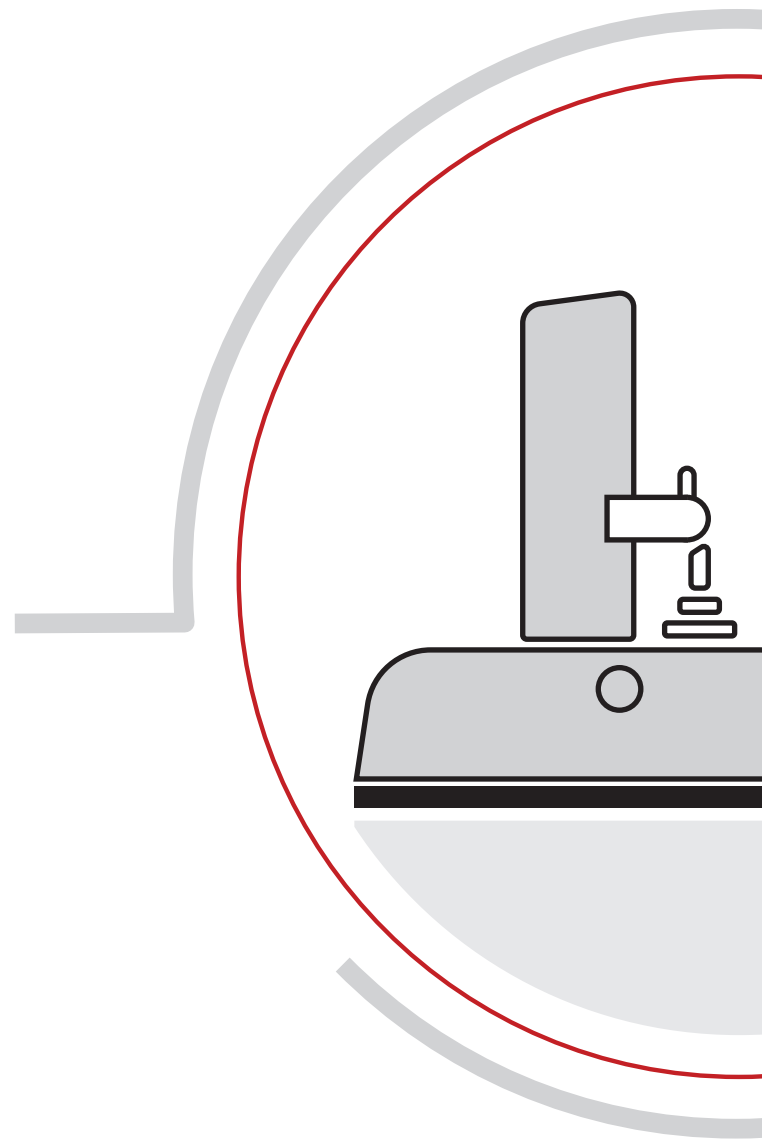

# WITH THE OPTIMA EM

## OPTIMA SERIES

CNC

---

OPTIMA

---

2CAMERA

---

BASIC

---

WOOD

---

SPECIAL SOLUTIONS

---



## OPTIMA SERIES

# OPTIMA CNC

The OPTIMA CNC is available customized with the desired configuration for any CNC and fully automated manufacturing system.

Absolute precision with easy operation.

Brand components and our image processing guarantee maximum process reliability and quality.



Emergency stop button



Also available with semi-automatic handling – autofocus with motorized C-axis.

### ADVANTAGES

- CNC control in X | Z and C
- High-precision spindle with power or vacuum clamping
- PWB EyeRay® CNC software
- CMOS digital camera with tele centric lens
- All in One PC 20.0" | Windows 10 64-Bit with touchscreen technology
- Motorized continuous fine adjustment in X and Y axes
- Tool management
- Tool inspection
- Label printer
- Device table
- Tray for toolholders
- Link to all machine controls and manufacturing processes
- Highest safety standards
- High concentricity
- Maximum measuring repeating accuracy

### TECHNICAL DATA

TYPE	<p><b>PRECISION POWER-SPINDLE</b> with clamping adapters SK, HSK, Capto   automatic clamping</p> <p><b>PRECISION VACUUM-SPINDLE</b> SK50 vacuum clamping   useable for all standard reductions  optional- reduction with mechanical clamping</p>
MEASURING RANGE	<p>∅ mm 400 / L mm 40 .... 400</p> <p>∅ mm 400 / L mm 40 .... 600</p> <p>∅ mm 400 / L mm 40 .... 700</p> <p>∅ mm 600 / L mm 40 .... 400</p> <p>∅ mm 600 / L mm 40 .... 600</p>
AXIS FIXATION	Pneumatic
FINE ADJUSTMENT	Motorized
MEASURING PROCEDURE	Image processing with EyeRay® CNC

# OPTIMA

Manual presetting with fast, easy and highly precise measuring methods – the right solution for all users.

Equipped with the most important standard measuring functions and for transferring tool data to the processing machines.

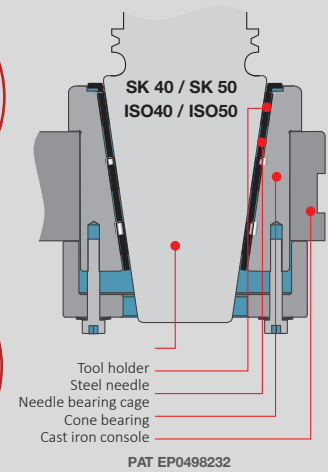
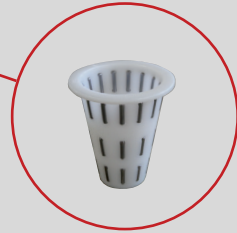

## TECHNICAL DATA

TYPE	Pneumatic clamping, practical design and ease of use
MEASURING RANGE	$\varnothing$ mm 400 / L mm 40 .... 400 $\varnothing$ mm 400 / L mm 40 .... 600 $\varnothing$ mm 400 / L mm 40 .... 700 $\varnothing$ mm 600 / L mm 40 .... 400 $\varnothing$ mm 600 / L mm 40 .... 600
AXIS FIXATION	Pneumatic
FINE ADJUSTMENT	Handwheel per axis
TOOL MOUNTING	Needle bearings or KV spindle with rotation clamp and vacuum feeder
MEASURING PROCEDURE	Image processing with EyeRay® Hawk or Buzzard

## ADVANTAGES

- Manual control in X | Z and C
- EyeRay® Software HAWK or BUZZARD
- All in One PC 20.0" with touchscreen technology
- Glasscale
- CMOS digital camera with tele centric lens
- EyeRay® autofocus: automatic and fast focusing of cutter
- Infinite fine adjustment in X- and Z-axes
- Measuring field offset in the X- and Z-axes
- With integral ISO50 or ISO40 spindles
- Spindle clamping
- Adapter and tool management
- Label printer
- Device table
- Tray for toolholders
- Link to all machine controls and manufacturing processes
- Highest safety standards
- High concentricity
- Maximum measuring repeating accuracy

# OPTIMA BASIC

The cost-effective and efficient ENTRY-LEVEL SOLUTION with all standard measuring functions meets all necessary customer requirements in the area of tool and material measurements. Suitable for measuring tasks directly in production.



## TECHNICAL DATA

TYPE	Pneumatic clamping, practical design and ease of use
MEASURING RANGE	∅ mm 400 / L mm 40 .... 400 ∅ mm 400 / L mm 40 .... 600
AXIS FIXATION	Pneumatic
FINE ADJUSTMENT	Handwheel per axis
TOOL MOUNTING	Needle bearings or KV spindle with rotation lock and vacuum pull in
MEASURING PROCEDURE	Image processing with EyeRay® Hawk

## ADVANTAGES

- Image processing with EyeRay® Software Hawk
- PWB PC solution with 20" screen
- Infinite fine adjustment in X- and Z-axis
- Quick focusing of the tool cutting edge
- CMOS digital camera with tele centric lens
- High concentricity due to needle bearing
- High measuring repeatability
- With integral ISO50 or ISO40 spindles
- Sturdy cast iron base

# OPTIMA SPECIAL SOLUTIONS

We have the know-how to meet your requirements. EVOSET offers a wide range of standard solutions to meet your requirements. Specific circumstances, however, often require a customized solution. EVOSET is the right partner for you here as well.

For many years, we have been working together with you to develop products and systems which are adapted to a variety of different applications. Close cooperation between customers and our development engineers ensures optimum solutions.





# OPTIMA WOOD



The new and worldwide unique presetting device especially for the wood industry.

- Easy management of units with the respective parameters
- Communication with the machine controller
- Writing to and reading from data media on the tool holders
- Modular software

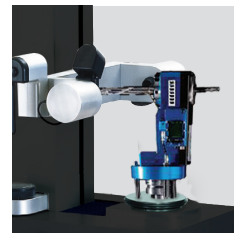

## TECHNICAL DATA

TYPE	Pneumatic clamping
MEASURING RANGE	∅ mm 400 / L mm 40 .... 400 ∅ mm 400 / L mm 40 .... 600
AXIS FIXATION	Pneumatic
FINE ADJUSTMENT	Handwheel per axis
TOOL MOUNTING	Needle bearings
MEASURING PROCEDURE	Image processing with EyeRay® WOOD

## ADVANTAGES

- Image processing with EyeRay® software
- Wood with aggregate management
- All-in-one PC with 20.0" touchscreen monitor for easy and quick operation
- Infinite fine adjustment in X- and Z-axis
- Quick focusing of the tool cutting edge
- CMOS digital camera with tele centric lens
- Label printer
- High concentricity due to needle bearing
- High measuring repeatability
- Smooth recirculating needle bearing guides
- Sturdy cast iron base
- Device table



- Adapter HSK-63 Wood for aggregates as well for tools with the shape HSK-B/D/F 63

## OFFSET VALUE (Z)

INTERNAL SHAPE	External shape
	SK50 / ISO50
HSK- BDF 40	15 mm
HSK- BDF 50	15 mm
HSK- BDF 63	15 mm
HSK- BDF 80	15 mm
HSK- BDF 100	52 mm
INTERNAL SHAPE	External shape
	SK50 / ISO50
HSK- BDF 63	52 mm

# TOOL BOY

The broadly equipped and secure mounting device for tools with various adapters.

Rely on the original and best-selling mounting aid worldwide.

## ADVANTAGES

- Safer and faster change of toolholding systems
- Accident-free and ergonomic working
- 8 x 45° indexable, assembly of tools without reclamping
- Suitable for all tool systems
- Best tool protection through DELRIN inserts
- No effort due to optimum ergonomics



DIN 69871/DIN 2080  
JIS B 6339 (MAS-BT)  
ANSI CATV-Flange  
Nr.  
ISO 30 400520  
ISO 35 400524  
ISO 40 400521  
ISO 45 400525  
ISO 50 400522



KENNAMETAL  
Widia / Tizit  
Nr.  
KM 32 400553  
KM 40 400550  
KM 50 400551  
KM 63 400552



DIN 69893  
HSK- (Form A- F)  
Nr.  
HSK-A32 400544  
HSK-A40 400545  
HSK-A50 400540  
HSK-A63 400541  
HSK-A80 400542



SANDVIK  
Capto  
Nr.  
Capto C3 400135  
Capto C4 400136  
Capto C5 400137  
Capto C6 400138  
Capto C8 400139



DIN 69880  
VDI 3425  
Nr.  
VDI 20 400580  
VDI 25 400585  
VDI 30 400581  
VDI 40 400582  
VDI 50 400583



# OPTIONS & ACCESSORIES

## CHC / Center Height Camera

Height measuring of turning tools.

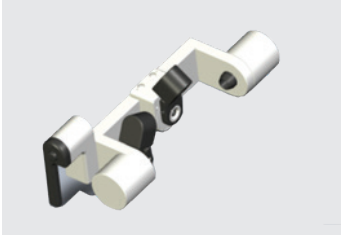

## LED ring light



## Precision power-spindle



## Indexing device for rotary tools



## Label printer



## Measuring field variations

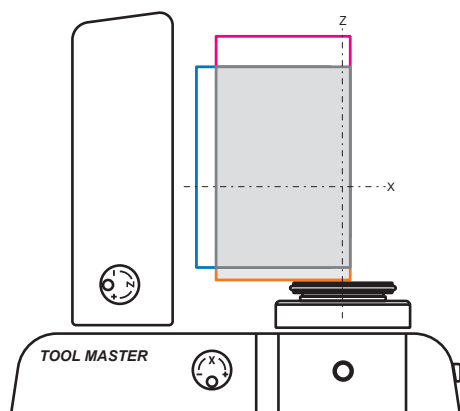

## YAC / Y-Axis Camera

Measuring of multi-edge tools with offset cutting.  
Measuring range + 20 mm up to - 20 mm

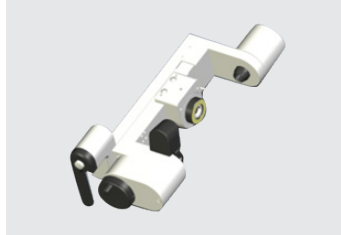

## Inspection light



## Precision vacuum-spindle

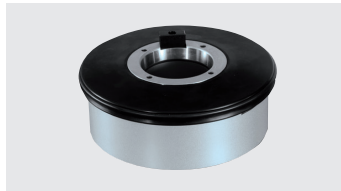

## Master mandril

- SK40 / SK50 :  $\phi$  30 x 330
- SK40 / SK50 :  $\phi$  30 x 90



## Device table



## VHC / Vertical -Horizontal Camera

Measuring in horizontal and vertical directions. The camera is horizontally and vertically adjustable with any intermediate angles- this allows measuring of cutting angles and radii.

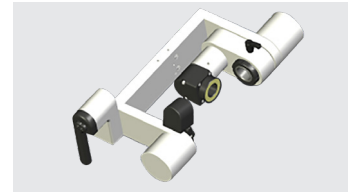

## Manual spindle brake

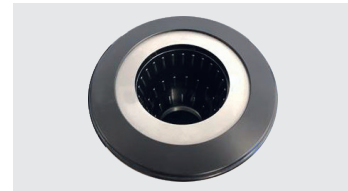

## Tray for toolholders



# CNC ADAPTERS | REDUCTIONS | ADAPTERS

## CNC Adapters

Special adapters on demand



SK	30   40   50
HSK	32   40   50   63   80   100
CAPTO	C3   C4   C5   C6   C8

## SK

- Reduction SK/ISO to SK/ISO  
In-house calibration ensures consistent quality
- Offset value is engraved on the reduction according to the following table

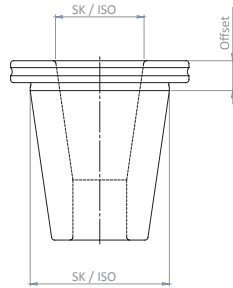

### Offset value (Z)

Internal shape	External shape	
	SK50 / ISO50	SK40 / ISO40
SK10	30 mm	30 mm
SK15	30 mm	30 mm
SK20	15 mm	15 mm
SK25	15 mm	15 mm
SK30	15 mm	15 mm
SK35	15 mm	15 mm
SK40	15 mm	-
SK45	15 mm	-

## HSK (shapes A to F)

- Reduction SK/ISO to HSK, available with and without clamping attachment
- Offset value is engraved on the reduction according to the following table

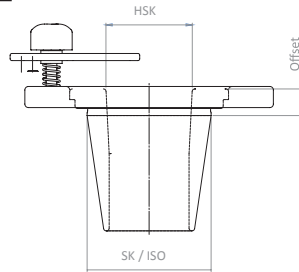

### Offset value (Z)

Internal shape	External shape	
	SK50 / ISO50	SK40 / ISO40
HSK-A25	15 mm	15 mm
HSK-A32	15 mm	15 mm
HSK-A40	15 mm	15 mm
HSK-A50	15 mm	15 mm
HSK-A63	15 mm	60 mm
HSK-A80	52 mm	-
HSK-A100	70 mm	-

## VDI with clamp lever

- Clamping of the VDI tool holder with clamping lever
- Clearance provided in the reduction for O-ring of the VDI shank

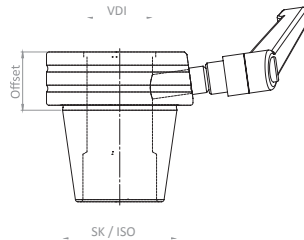

### Offset value (Z)

Internal shape	External shape	
	SK50 / ISO50	SK40 / ISO40
VDI16	50 mm	50 mm
VDI20	35 mm	35 mm
VDI25	35 mm	35 mm
VDI30	35 mm	35 mm
VDI40	35 mm	70 mm
VDI50	35 mm	90 mm
VDI60	100 mm	-

## VDI with index

- 4x90° indexing on reduction. VDI tool holder is aligned in reduction by means of centring pins
- Clearance provided in reduction for O-ring of the VDI shank

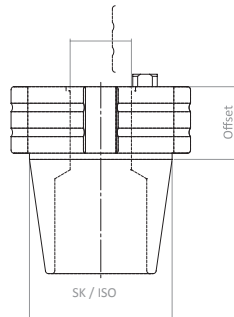

### Offset value (Z)

Internal shape	External shape	
	SK50 / ISO50	SK40 / ISO40
VDI16	50 mm	50 mm
VDI20	35 mm	35 mm
VDI25	35 mm	35 mm
VDI30	35 mm	35 mm
VDI40	35 mm	80 mm
VDI50	35 mm	-
VDI60	100 mm	-
VDI80	140 mm	-

## Capto 'Easy'

- Capto tool holder is centred using the 3 highest points of the polygon in the reduction, fixed with clamping claw

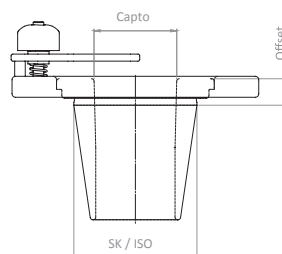

### Offset value (Z)

Internal shape	External shape	
	SK50 / ISO50	SK40 / ISO40
C3	15 mm	-
C4	15 mm	-
C5	15 mm	-
C6	15 mm	-
C8	52 mm	-
C10	80 mm	-







The world's leading and proven image processing software EyeRay® for pre-setting, measuring, testing and managing tools and integration into existing manufacturing processes.





Navigate through all functions quickly and with confidence thanks to the extensive software modules and self-explanatory measuring programs.

- Easy to operate with only six basic icons
- Self-explanatory function keys
- Expandable and modular for any special measuring functions and special requirements
- Fast measuring with favourites fields
- Fully automated operating options
- Interfaces to all possible machine controls and manufacturing processes
- Guaranteed process reliability
- Constant precise measuring results

The EyeRay® software solution puts you at the forefront – it meets all customer and production requirements for the SMART FACTORY. Take the step towards digitization and networking together with us.



CNC		CNC	Buzzard	Hawk	Wood	
	Pilot	X	-	-	-	
	Power spindle	X	O	O	-	
	KV spindle	X	O	O	-	
	Pilot	X	-	-	-	
MEASURING METHODS						
	Preset	X	X	X	X	
	Maximum	X	X	X	X	
	Screen method	X	X	X	X	
	Multi cutting method	X	X	X	X	
	Front light method	X	X	X	X	
	Front ring light	O	O	O	O	
	Fixed axis	X	X	X	O	
	Centre point method	X	X	X	X	
	Theoretical angle and radius by default	X	X	X	X	
	Point measuring	X	X	X	X	
	Centre height measuring	O	O	O	O	
	DXF	O	O	O	O	
		X	X	O	O	
MEASURING FUNCTIONS						
	BASIC	Highest point in horizontal (X) und vertical (Z) direction (Point measuring)	X	X	X	X
		Measurement of the height of a contour with a specified diameter value/ also angle measuring	X	X	X	X
		Measuring by a single point in height and diameter (suitable for master mandrill)	X	X	X	X
		Measuring of the angle, radius and theoretical intersection point of the cutting edge	X	X	X	X
		Maximum point horizontal (X)	X	X	X	X
		Maximum point vertical (Z)	X	X	X	X
		Measuring of the angle, radius as well as the highest point vertical (Z) and horizontal (X)	X	X	X	X
		Measuring of the radius, also indication of the radius centre point	X	X	X	X
		To create tailor made measuring functions (MF can be modified)	X	X	X	X
		Additional measuring functions	X	X	-	X
	Tailor made measuring functions	X	X	-	X	
	Store tailor made function	X	X	-	X	
	Open tailor made function	X	X	-	X	
	Delete tailor made function	X	X	-	X	
	Customized measuring function	O	O	O	O	
AGGREGATE MANAGEMENT						
	Graphics of the aggregates	-	-	-	X	
	Geometric data	-	-	-	X	
	Technology data	-	-	-	X	
	Print aggregate list	-	-	-	X	

 BASIC SETTINGS		CNC	Buzzard	Hawk	Wood
 EINSTELLUNGEN	Illumination setting	X	X	X	X
	Camera parallelism	X	X	X	X
	Calibration of the camera pixel size	X	X	X	X
	Parallelism correction	X	X	X	X
	Absolute zero point	X	X	X	X
	Parameters	X	X	X	X
 PRINTING					
 DRUCKEN	Print label standard format	X	X	X	X
	Print customized label	O	O	-	O
	Print tool list	X	X	X	X
	Print measuring report	X	O	-	-
 DATA BASE					
 DATENBANK	Reference points data base	X	X	X	X
	Creation of reference points with offset values	X	X	X	X
	Creation of reference points with reference values	X	X	X	X
	Add images to the reference point	X	X	X	X
	Swap axes	X	X	X	X
	Change counting direction	X	X	X	X
	R/D mode for each axis definable	X	X	X	X
	Tool data base	X	X	-	-
	Toolmangement	X	O	-	O
	Management of multi cutters	X	X	-	O
	Nominal values per cutting edge	X	X	-	O
	Assignment of a measuring function per cutting edge	X	O	-	-
	Tools history	X	O	-	-
	Tool sheet	X	X	X	X
	Create a new tool	X	-	-	-
	Backup and restore	X	X	X	-
 DATA TRANSFER					
 DATENAUSGABE	Print tool sheet	X	X	X	X
	Store tool sheet	X	X	X	X
	Open Tool sheet	X	X	-	X
	Data output as a file	O	O	O	O
	Data output on a data carrier	O	O	O	O
	Excel export	O	O	-	O
	Open PDF file	X	X	X	X

„X“ Standard „O“ Optional

# SMART FACTORY SOLUTION

## COMPLETE SOLUTION FOR YOUR MANUFACTURING

- DIGITALIZATION
- DATA TRANSFER

**EVOSET** offers you a cost-effective and energy-efficient manufacturing process which configures and perfects itself – we guarantee process reliability, continuous data transfer, smooth machining processes and integration into existing and new production processes.

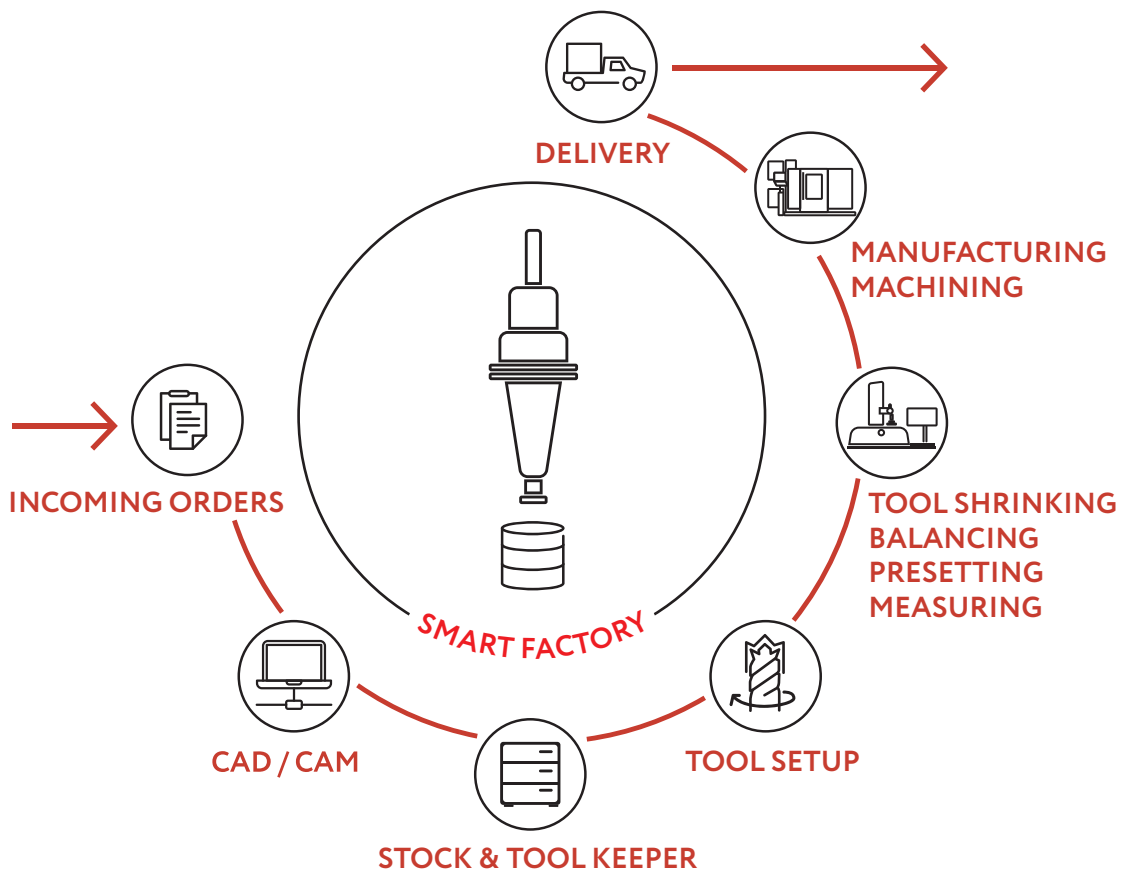

## DIGITALIZATION

Use the **EVOSET** complete solution to manage product data, distribute information, automate workflows and optimise the collaboration between order management, work preparation, quality assurance and production.





With a completely revised software based on the latest technologies, all production-related documents can be archived efficiently and intelligently. All data and information are stored centrally in a database and can be made available at any required location through the network. The **SMART FACTORY** is based on correct data and a tool data management system.

**• SAFETY**

The great variety of interfaces to all possible production systems and centres allows monitoring of the tool processes, immediately alerting operators in case of a malfunction. This means that costly errors can already be identified and removed during the active process.

**• SPEED**

Conversion and programming times are reduced to a minimum. Operating steps, work instructions, etc. are generated automatically and flawlessly in work flows and provided to the employees in production.

**• OPTIMISED PROCESSES**

The tools mostly organise themselves, using digitally networked systems.

**• TOOL DATA**

A complete 3D database with tool components from different manufacturers is available.

**• INTERFACES**

We offer interfaces to numerous ERP systems and to the OPTIMA program.

**• TOOL MONITORING**

Tool monitoring allows users to monitor tools used throughout the entire production process, check service life data, organize tools and replace tools in a timely manner. This prevents loss of quality, tool breakage and machine downtimes.

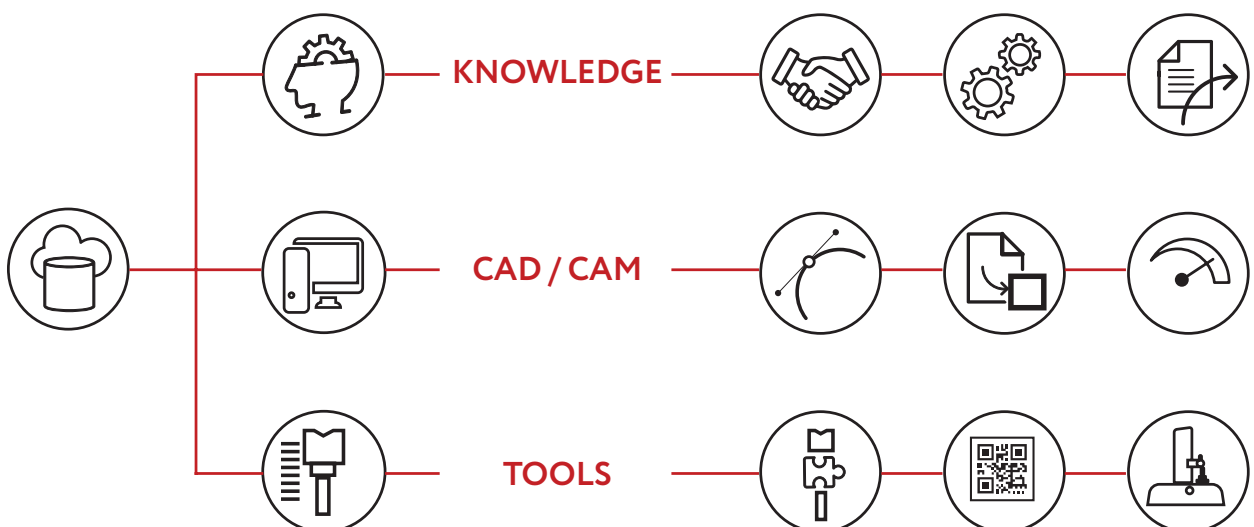

## DATA TRANSFER



DATA LINKS ensure fault-free and clearly structured transfer of measuring and tool data. The EVOSET software supports all possible linking interfaces to machine controls.

---

### DATA TRANSFER BY

- Post-processor
- RFID data media (Balluff)
- QR Code
- Customer solution

---

Achieve more machine capacity and safety by excluding incorrect operation. Users can fully focus on the smooth operation of the CNC machines without being distracted by data input.

## SERVICE & SUPPORT

Our highly qualified **EVOSET** engineers and service employees support you from planning to commissioning and product training.

With our remote service, we can guarantee fast problem diagnostics and speedy parts delivery including repairs and maintenance.

- Hotline +41 27 922 04 50 or [service@evoaset.com](mailto:service@evoaset.com)
- Remote service (online support) – save time and money here as well
- Software updates (new or optimised functions)
- Conversion and retrofit kits
- Subsequent data linking
- Updates
- Individual programming
- Spare parts
- Accessories

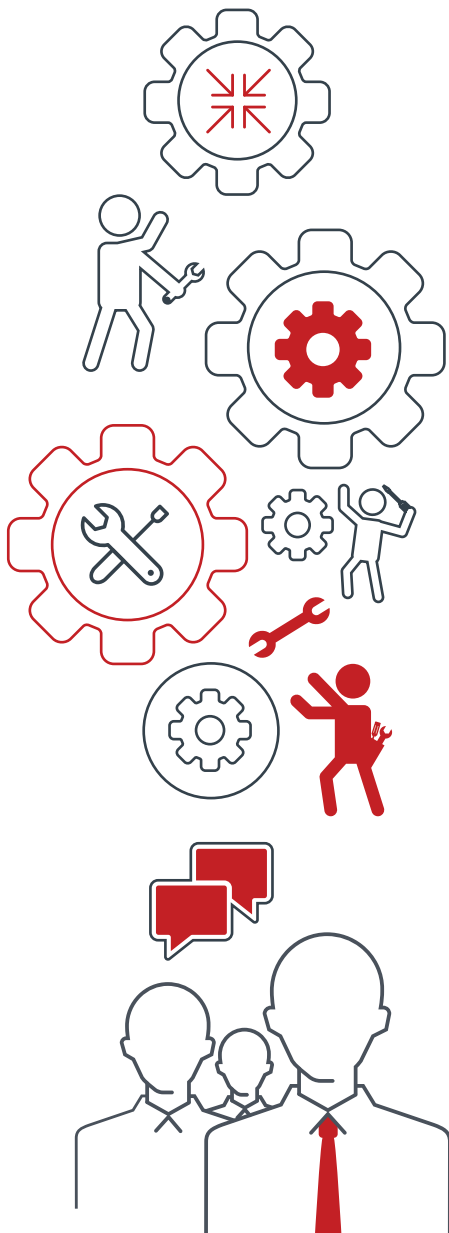

Basic and advanced product training at the **EVOSET** training room or at your facility – we can turn you into a professional.

---

### TRAINING TARGET GROUP:

- Manufacturing specialists
  - Tool setters
  - Work preparation employees
  - Programmers
  - Application engineers
  - Tool technology engineers
- 

**EVOSET** customers place their trust in us – thanks to our unrivalled support and service.

You can rely on us worldwide...

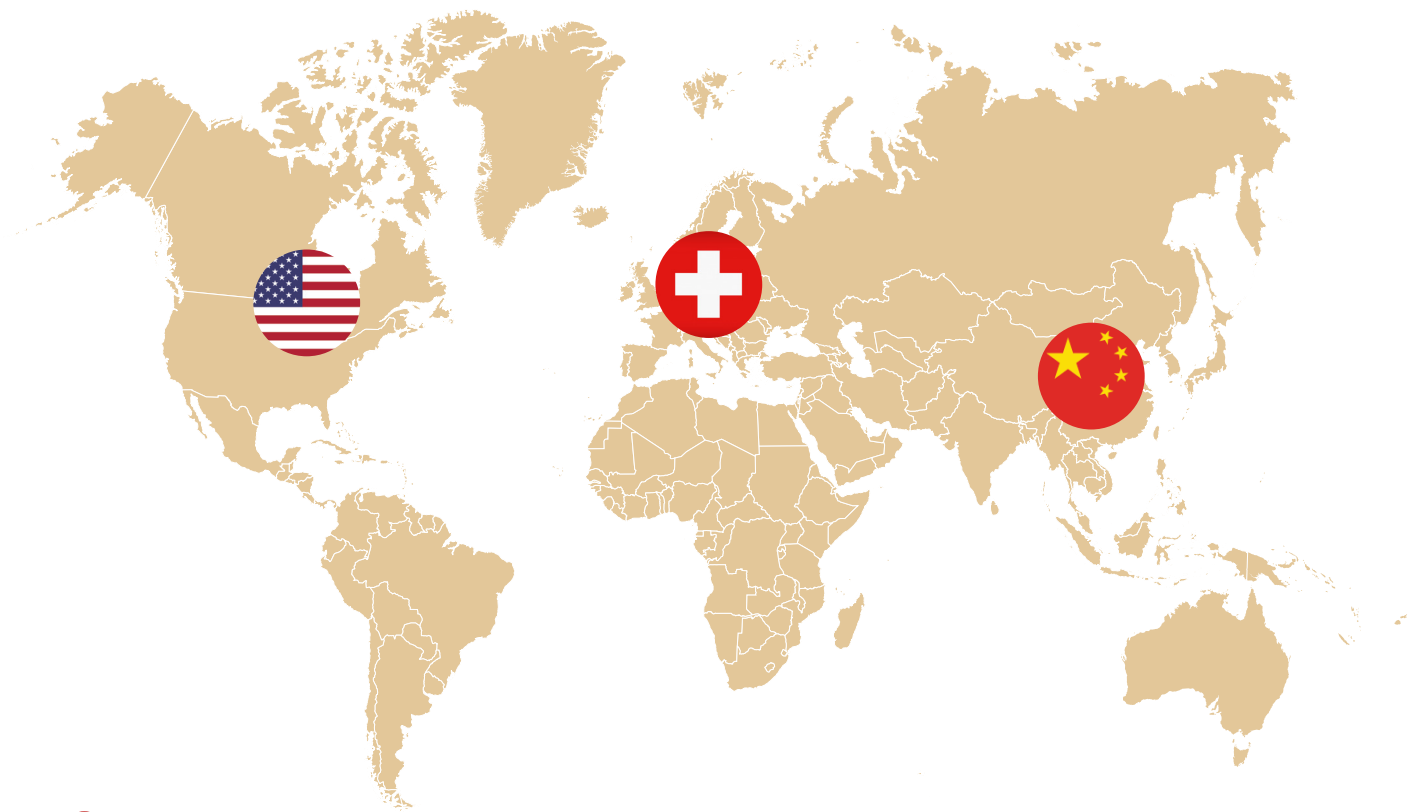

Headquarter & Production facility



Technical office



Technical office

# EVOSSET

...for best measuring results



Evoset AG | Besche Mattenstrasse 1 | 3940 Steg/VS | Switzerland  
Evoset AG | Schwättenmos 6 | 8126 Zumikon/ZH | Switzerland

Fon +41 27 922 04 50  
info@evoset.com  
service@evoset.com  
[www.evoset.com](http://www.evoset.com)