

HORIZON PREMIUM



HORIZON PREMIUM

INTRODUCTION

The HORIZON PREMIUM instruments fulfill today's requirements of high accuracy quality control equipment in production areas and take into consideration EN ISO 9000 standards.

The instruments may be used in a workshop area or installed in a quality control room for checking of measuring gauges and setting of all types of comparative measuring equipment. The well-designed, reliable new concept, obtained by superior engineering, ensures high precision and optimum results by easy manipulation as well as a valuable level of productivity.

The modular design allows the selection between two measuring systems: analog signal output and Heidenhain display unit or digital signal output and computer with TFT touch screen and Trimos-WinDHI software.

Instruments with a measuring range from 500 to 3000 mm are available, all of them built in one single piece. All measuring ranges being direct, it means that the whole measuring range is available without adjustment or intermediate re-calibration.

IDEAL FOR THE USE IN LABORATORY AND IN THE WORKSHOP

NEW ERGONOMIC CONCEPT

MEASURING CARRIAGE WITH FINE ADJUSTMENT

LARGE RANGE OF ACCESSORIES

ADJUSTABLE MEASURING FORCE

3 DISPLAYS AVAILABLE

MODULAR SYSTEM DESIGN

DIRECT MEASUREMENT OVER THE WHOLE RANGE

DESCRIPTION



HORIZON PREMIUM

DISPLAY / SOFTWARE

HORIZON PREMIUM (HPA)

Heidenhain ND287 or ND1100 display units



Heidenhain ND1100



Heidenhain ND287



LINEAR MEASURING SYSTEM, MIN./MAX. VALUE HOLD

DIGITAL DISPLAY

ZERO SETTING OF THE DISPLAY AND PRESET INPUT

PARAMETER SETTINGS AND CLASSIFICATION

CONFIGURATION OF THE DISPLAY USING EXTERNAL CONTACT

RS232 DATA OUTPUT

HORIZON PREMIUM (HPD)

TRIMOS WinDHI

TRIMOS-WinDHI Software allows the performance of all required measuring functions and the connection to the temperature compensation system TempComp as well as to a gauge inspection and management system.



PC WITH TOUCH SCREEN

DDE-SERVER (FOR EXCEL, WORD, ETC.)

GRAPHIC HELP FOR MEASURING FUNCTIONS

DATA TRANSFER USING A FOOT PEDAL

DIGITAL DISPLAY OF THE SELECTED MEASURING FORCE IN NEWTON (N)

DIRECT DISPLAY OF ALL LENGTH MEASURING VALUES AND MIN./MAX. VALUE HOLD

MEASURING WITH 9 REFERENCES

INVERSION OF MEASURING DIRECTION SIGN (+/-)

COMPATIBLE WITH TEMPERATURE COMPENSATION SYSTEM TEMPCOMP (SEE § LABCONCEPT)

QMSOFT

Trimos recommends the QMSOFT software package for inspection and management of all measuring tools available.



INTEGRATED DRIVERS FOR TRIMOS INSTRUMENTS

REQUIRED NOMINAL SIZES AND TOLERANCES AVAILABLE ACCORDING ALL STANDARDS

CUSTOMIZED INSPECTION CERTIFICATES



TECHNICAL SPECIFICATIONS

Horizon Premium		500	1000	1500	2000	3000
Measuring range	mm (in)	550 (21)	1050 (41)	1550 (61)	2050 (80)	3050 (120)
Max. permissible errors ¹⁾	µm	0.7 + L (mm)/1000				
Repeatability (2s) ¹⁾	µm	0.2				
Resolutions	mm (in)	0.01 / 0.001 / 0.0001 (.001 / .0001 / .00001)				
Max. displacement speed	mm/s	1.5				
Measuring force	N	0 ÷ 12				
Operational temperature	°C	+10 ÷ +40				
Temperature of storage	°C	-10 ÷ +40				
Relative humidity	%	20 ÷ 80				
Weight	kg	94	123	152	181	239

¹⁾ Values valid at temperature of 20 ± 0.2 °C and relative humidity of 50 ± 5%.

SCHEMA

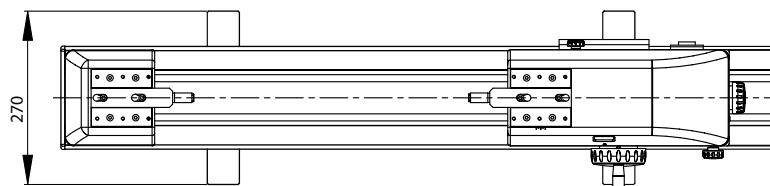
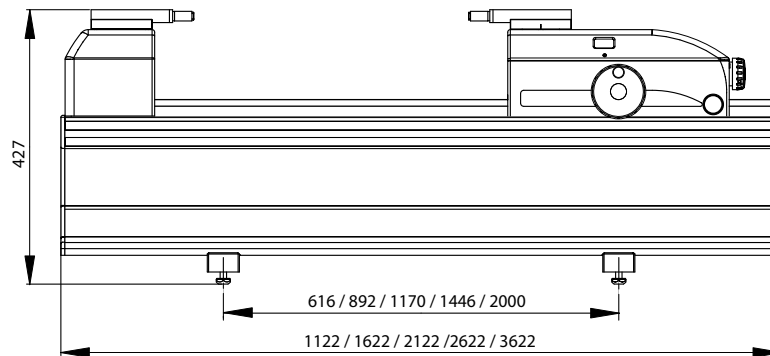

HORIZON PREMIUM

STANDARD INSTRUMENT

The Horizon Premium (HPA) instruments are supplied as follows:

Instrument according to specifications
Pair of anvils with tungsten carbide surface (HPA-1)
Lapping plate (TA-TO-302)
Protection cover (TEL.HO500 / 1000 / 1500 / 2000)
Allen key set (TA-TO-004)
User's manual (750 50 0015 03)
Test certificate

The Horizon Premium (HPD) instruments are supplied as follows:

Instrument according to specifications
Pair of anvils with tungsten carbide surface (HPA-1)
PC with interface, touch screen ¹⁾ , adjustable support ¹⁾ , touch screen pen ¹⁾
Foot pedal for data transfer (TELMA31)
Opto-RS connection cable for measuring force (TVM.O-PC/AT.9P)
Lapping plate (TA-TO-302)
Protection cover (TEL.HO500 / 1000 / 1500 / 2000)
Allen key set (TA-TO-004)
User's manual (750 50 0015 03)
Test certificate

¹⁾ Not included in version HPD-B. Touch screen replaced by a regular TFT screen.

CODE NUMBERS

Horizon Premium (HPA)		
HPA500	700 202 10 01	Measuring range 500 mm
HPA1000	700 202 20 01	Measuring range 1000 mm
HPA1500	700 202 30 01	Measuring range 1500 mm
HPA2000	700 202 40 01	Measuring range 2000 mm
HPA3000	700 202 50 01	Measuring range 3000 mm

Horizon Premium (HPD)				
HPD500	700 212 10 01	HPD500B	700 212 10 02 ¹⁾	Measuring range 500 mm
HPD1000	700 212 20 01	HPD1000B	700 212 20 02 ¹⁾	Measuring range 1000 mm
HPD1500	700 212 30 01	HPD1500B	700 212 30 02 ¹⁾	Measuring range 1500 mm
HPD2000	700 212 40 01	HPD2000B	700 212 40 02 ¹⁾	Measuring range 2000 mm
HPD3000	700 212 60 01	HPD3000B	700 212 60 02 ¹⁾	Measuring range 3000 mm

¹⁾ HPD-B: With TFT screen, no adjustable support.

APPLICATIONS



Checking of ring gauges
(TA-SU-313/TEL16.1/HPA-1)

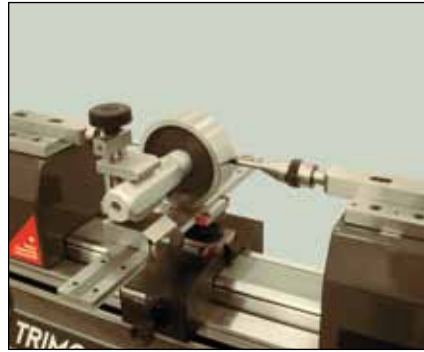

Checking of plug gauges
(HPA-1/TULM6/L05/LABC-15)

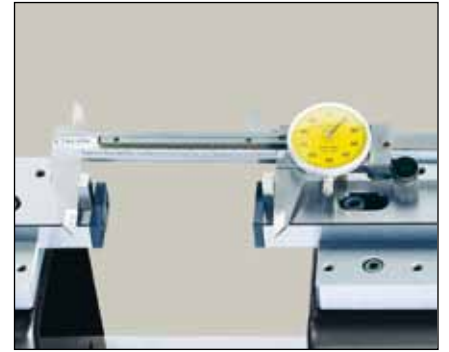

Checking of calipers (TEL5.10)

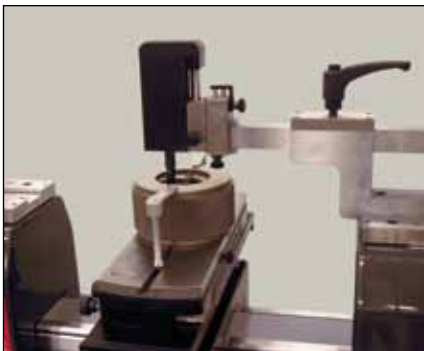

HPD: Checking of thread ring gauges
(TA-SU-313/LABC-70/TA-SU-354)



Checking of thread plug gauges (HPA-1/TEL6/3P/0.17-3.2/S6.5/LABC-15)



Checking of external micrometers
(HPA-1/TULM14)



Checking of snap gauges
(TA-SU-313/TEL14N)



Checking of dial indicators (TEL5CN)

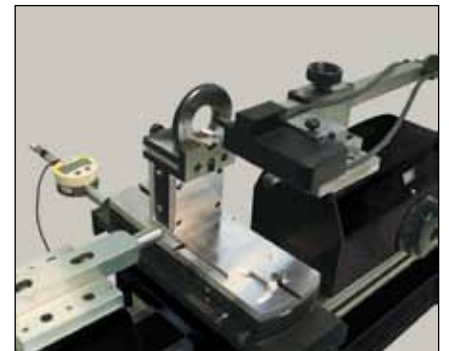

HPD: Checking of taper thread ring gauges (LABC80)

HORIZON PREMIUM

APPLICATIONS

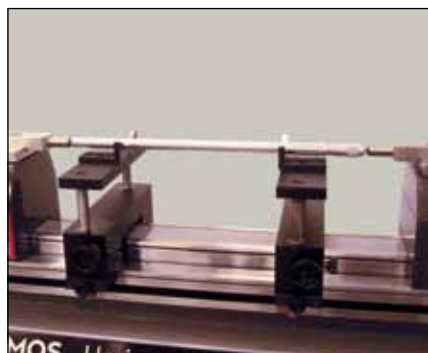

Setting of 2-point internal micrometers (HPA-1/TELMA7/TELMN7.2)



Checking of depth gauges (TEL5/TULM19)



HPA: Checking of thread ring gauges (TEL18)



HPA: Measurement of cylindrical parts (TA-MS-303)



Large micrometer control (TEL5/TEL11/LABC20)



Setting of 2-point bore gauges (TEL5/TA-SU-301)



Setting of a large gauge (TEL5)